

# DrayTek

## Vigor2915 Series

Dual-WAN Security Router



QUICK START GUIDE (WIRED MODEL)

V1.2

# Vigor2915 Series Dual-WAN Security Router Quick Start Guide (For Wired Model)

Version:1.2

Firmware Version: V4.3.3

(For future update, please visit [DrayTek web site](http://www.draytek.com))

Date: January 6, 2022

## Intellectual Property Rights (IPR) Information

### Copyrights

© All rights reserved. This publication contains information that is protected by copyright. No part may be reproduced, transmitted, transcribed, stored in a retrieval system, or translated into any language without written permission from the copyright holders.

### Trademarks

The following trademarks are used in this document:

- Microsoft is a registered trademark of Microsoft Corp.
- Windows 8, 10 and Explorer are trademarks of Microsoft Corp.
- Apple and Mac OS are registered trademarks of Apple Inc.
- Other products may be trademarks or registered trademarks of their respective manufacturers.

## Safety Instructions and Approval

### Safety Instructions

- Read the installation guide thoroughly before you set up the router.
- The router is a complicated electronic unit that may be repaired only by authorized and qualified personnel. Do not try to open or repair the router yourself.
- Do not place the router in a damp or humid place, e.g. a bathroom.
- Do not stack the routers.
- The router should be used in a sheltered area, within a temperature range of 0 to +40 Celsius.
- Do not expose the router to direct sunlight or other heat sources. The housing and electronic components may be damaged by direct sunlight or heat sources.
- Do not deploy the cable for LAN connection outdoor to prevent electronic shock hazards.
- Keep the package out of reach of children.
- When you want to dispose of the router, please follow local regulations on conservation of the environment.

### Warranty

We warrant to the original end user (purchaser) that the router will be free from any defects in workmanship or materials for a period of two (2) years from the date of purchase from the dealer. Please keep your purchase receipt in a safe place as it serves as proof of date of purchase. During the warranty period, and upon proof of purchase, should the product have indications of failure due to faulty workmanship and/or materials, we will, at our discretion, repair or replace the defective products or components, without charge for either parts or labor, to whatever extent we deem necessary to restore the product to proper operating condition. Any replacement will consist of a new or re-manufactured functionally equivalent product of equal value, and will be offered solely at our discretion. This warranty will not apply if the product is modified, misused, tampered with, damaged by an act of God, or subjected to abnormal working conditions. The warranty does not cover the bundled or licensed software of other vendors. Defects which do not significantly affect the usability of the product will not be covered by the warranty. We reserve the right to revise the manual and online documentation and to make changes from time to time in the contents hereof without obligation to notify any person of such revision or changes.



## EU Declaration of Conformity

We DrayTek Corp. , office at No.26, Fushing Rd., Hukou, Hsinchu Industrial Park, Hsinchu 303, Taiwan, declare under our sole responsibility that the product

- **Product name:** Dual-WAN Security Router
- **Model number:** Vigor2915 Series
- **Manufacturer:** DrayTek Corp.
- **Address:** No.26, Fushing Rd., Hukou, Hsinchu Industrial Park, Hsinchu 303, Taiwan

is in conformity with the relevant Union harmonisation legislation:

EMC Directive 2014/30/EU , Low Voltage Directive 2014/35/EU , ErP 2009/125/EC and RoHS 2011/65/EU with reference to the following standards

Standard	Version / Issue date
EN 55032	2012+AC:2013 class B
EN 61000-3-2	2014 Class A
EN 61000-3-3	2013
EN 55024	2010+A1:2015
EN 62368	2014+A11:2017
EC No. 1275/2008	2008

Hsinchu  
(place)

22nd June, 2019  
(date)

  
Calvin Ma / President  
(Legal Signature)



## Regulatory Information

### Federal Communication Commission Interference Statement

This equipment has been tested and found to comply with the limits for a Class B digital device, pursuant to Part 15 of the FCC Rules. These limits are designed to provide reasonable protection against harmful interference in a residential installation. This equipment generates, uses and can radiate radio frequency energy and, if not installed and used in accordance with the instructions, may cause harmful interference to radio communications. However, there is no guarantee that interference will not occur in a particular installation. If this equipment does cause harmful interference to radio or television reception, which can be determined by turning the equipment off and on, the user is encouraged to try to correct the interference by one of the following measures:

- Reorient or relocate the receiving antenna.
- Increase the separation between the equipment and receiver.
- Connect the equipment into an outlet on a circuit different from that to which the receiver is connected.
- Consult the dealer or an experienced radio/TV technician for help.

This device complies with Part 15 of the FCC Rules. Operation is subject to the following two conditions:

- (1) This device may not cause harmful interference, and
- (2) This device may accept any interference received, including interference that may cause undesired operation.

USA Local Representative	Company name	ABP International Inc.			
	Address	13988 Diplomat Drive Suite 180 Dallas TX 75234			
	ZIP Code	75234	E-mail	rmesser@abptech.com	
	Contact Person	Mr. Robert Messer	Tel.	19728311600	

### Caution:

- Any changes or modifications not expressly approved by the party responsible for compliance could void the user's authority to operate this equipment.

## External Power Supply ErP Information

	1	2	3	4	5	6	7	8	9
A Manufacturer	CWT	CWT	CWT	CWT	CWT	APD	APD	APD	APD
B Address	No. 222, Sec. 2, Nankan Rd., Lujhu Township, Taoyuan County 338, Taiwan	No. 222, Sec. 2, Nankan Rd., Lujhu Township, Taoyuan County 338, Taiwan	No. 222, Sec. 2, Nankan Rd., Lujhu Township, Taoyuan County 338, Taiwan	No. 222, Sec. 2, Nankan Rd., Lujhu Township, Taoyuan County 338, Taiwan	No. 222, Sec. 2, Nankan Rd., Lujhu Township, Taoyuan County 338, Taiwan	No.5, Lane 83, Lung-Sou St., Taoyuan City 330, Taiwan	No.5, Lane 83, Lung-Sou St., Taoyuan City 330, Taiwan	No.5, Lane 83, Lung-Sou St., Taoyuan City 330, Taiwan	No.5, Lane 83, Lung-Sou St., Taoyuan City 330, Taiwan
C Model identifier	2ABB012F UK 2ABB012F EU	2ABB018F UK 2ABB018F EU	2ABL024F UK 2ABL024F EU	2ABL030F UK 2ABL030F EU	2ABN036F UK 2ABN036F EU	WA-12M12FG WA-12M12FK	WB-18D12FG WB-18D12FK	WA-24Q12FG WA-24Q12FK	WA-36A12FG WA-36A12FK
D Input voltage	100-240V	100-240V	100-240V	100-240V	100-240V	100-240V	100-240V	100-240V	100-240V
E Input AC frequency	50/60Hz	50/60Hz	50/60Hz	50/60Hz	50/60Hz	50/60Hz	50/60Hz	50/60Hz	50/60Hz
Output voltage DC	12.0V	12.0V	12.0V	12.0V	12.0V	12.0V	12.0V	12.0V	12.0V
F Output current	1.0A	1.5A	2.0A	2.5A	3.0A	1.0A	1.5A	2.0A	3.0A
G Output power	12.0W	18.0W	24.0W	30.0W	36.0W	12.0W	18.0W	24.0W	36.0W
H Average active efficiency	84.9%	86.2%	87.6%	87.8%	89.8%	83.7%	85.4%	88.6%	88.2%
I Efficiency at low load 10%	73.6%	78.0%	81.3%	83.3%	83.7%	74.5%	80.5%	86.4%	85.4%
J No-load power consumption	0.07W	0.07W	0.07W	0.07W	0.07W	0.07W	0.10W	0.07W	0.10W

\*The external power supply used for each product will be model dependent.

For more update, please visit [www.draytek.com](http://www.draytek.com).



## ***Table of Contents***

<b>1. Package Content .....</b>	<b>1</b>
<b>2. Panel Explanation.....</b>	<b>2</b>
2.1 Vigor2915 .....	2
<b>3. Hardware Installation .....</b>	<b>4</b>
3.1 Network Connection .....	4
3.2 Wall-Mounted Installation .....	5
<b>4. Software Configuration .....</b>	<b>6</b>
<b>5. Customer Service .....</b>	<b>12</b>

# 1. Package Content

Take a look at the package content. If there is anything missed or damaged, please contact DrayTek or dealer immediately.



**Vigor router**

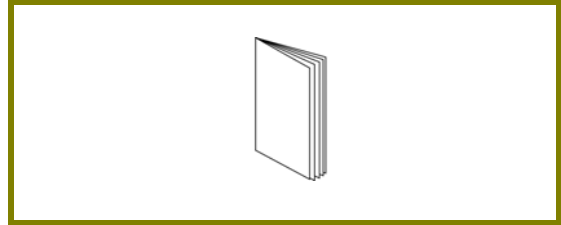

**Quick Start Guide**

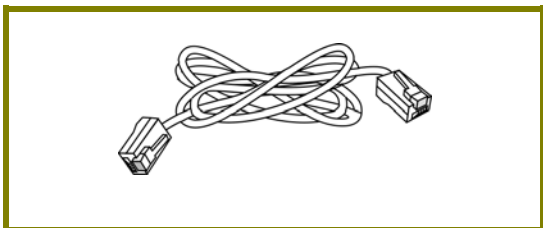

**RJ-45 Cat-5 Ethernet Cable**

The type of the power adapter depends on the country that the router will be installed. \* The maximum power consumption is *12 Watts*.

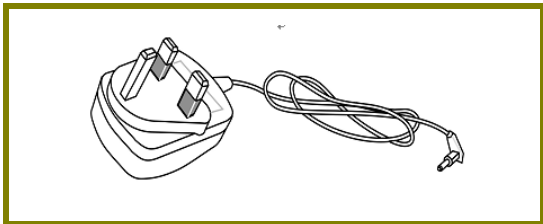

**UK-type Power Adapter**

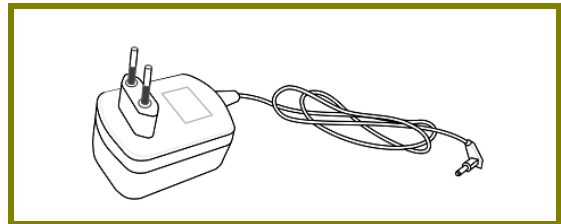

**EU-type Power Adapter**

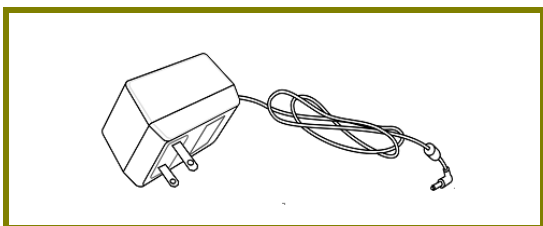

**USA/Taiwan-type Power Adapter**

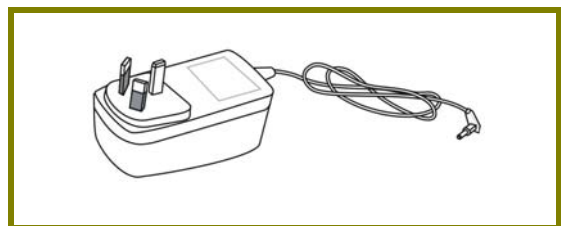

**AU/NZ-type Power Adapter**

## 2. Panel Explanation

### 2.1 Vigor2915

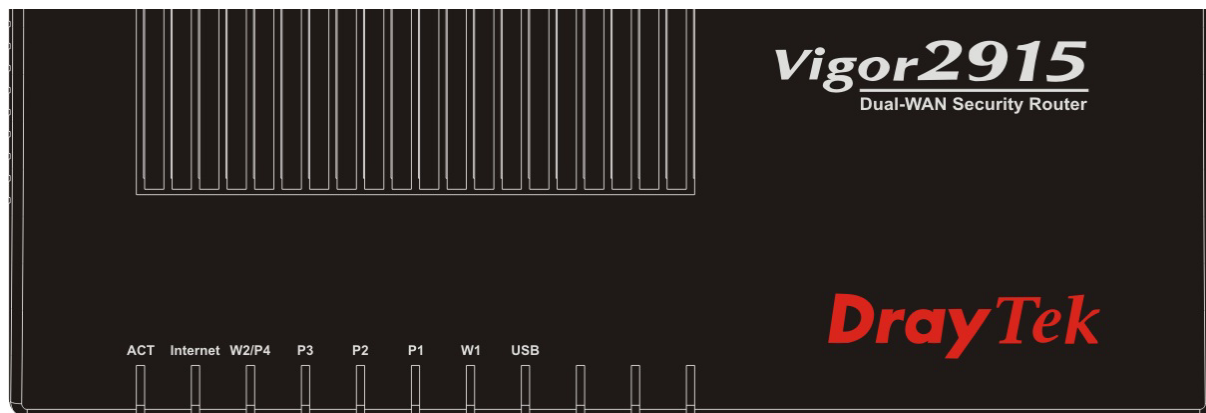

LED	Status	Explanation
ACT	Blinking	The router is powered on and running normally.
	Off	The router is powered off.
Internet	On	Internet connection is ready.
	Off	Internet connection is not ready.
	Blinking	The data is transmitting.
W2/P4	On	The WAN/LAN port is connected.
	Off	The WAN/LAN port is disconnected.
	Blinking	The data is transmitting.
P3~P1	On	The LAN port is connected.
	Off	The LAN port is disconnected.
	Blinking	The data is transmitting.
W1	On	The WAN port is connected.
	Off	The WAN port is disconnected.
	Blinking	The data is transmitting.
USB	On	USB device is connected and ready for use.
	Blinking	The data is transmitting.



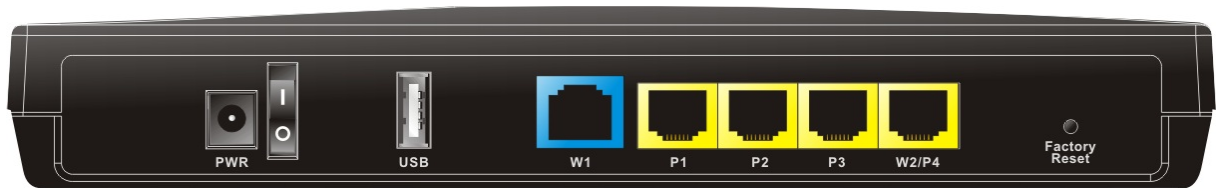

Interface	Description
PWR	Connector for a power cord.
ON/OFF	Power Switch.
USB	Connector for a USB device (for 3G/4G USB Modem or printer or Environmental Thermometer).
W1	Connector for local network devices or modem for accessing Internet.
P1~P3	Connecters for local network devices.
W2/P4	The function of this connector is adjustable and controlled by web user interface. It can perform the job as a WAN port (for accessing Internet) or as a LAN port (for local network devices).
Factory Reset	Restore the default settings. Usage: Turn on the router (ACT LED is blinking). Press the hole and keep for more than 5 seconds. When you see the ACT LED begins to blink rapidly than usual, release the button. Then the router will restart with the factory default configuration.

### 3. Hardware Installation

This section will guide you to install the router through hardware connection and configure the router's settings through web browser.

Before starting to configure the router (taking Vigor2915 for example), you have to connect your devices correctly.

#### 3.1 Network Connection

1. Connect the cable Modem/DSL Modem/Media Converter to any WAN port of router with Ethernet cable (RJ-45).
2. Connect one end of an Ethernet cable (RJ-45) to one of the LAN ports (P1~P3) of the router and the other end of the cable (RJ-45) into the Ethernet port on your computer.
3. Connect one end of the power cord to the router's power port on the rear panel, and the other side into a wall outlet.
4. Power on the device by pressing down the power switch on the rear panel.
5. The system starts to initiate. After completing the system test, the ACT LED will light up and start blinking.

(For the detailed information of LED status, please refer to section 2. Panel Explanation)

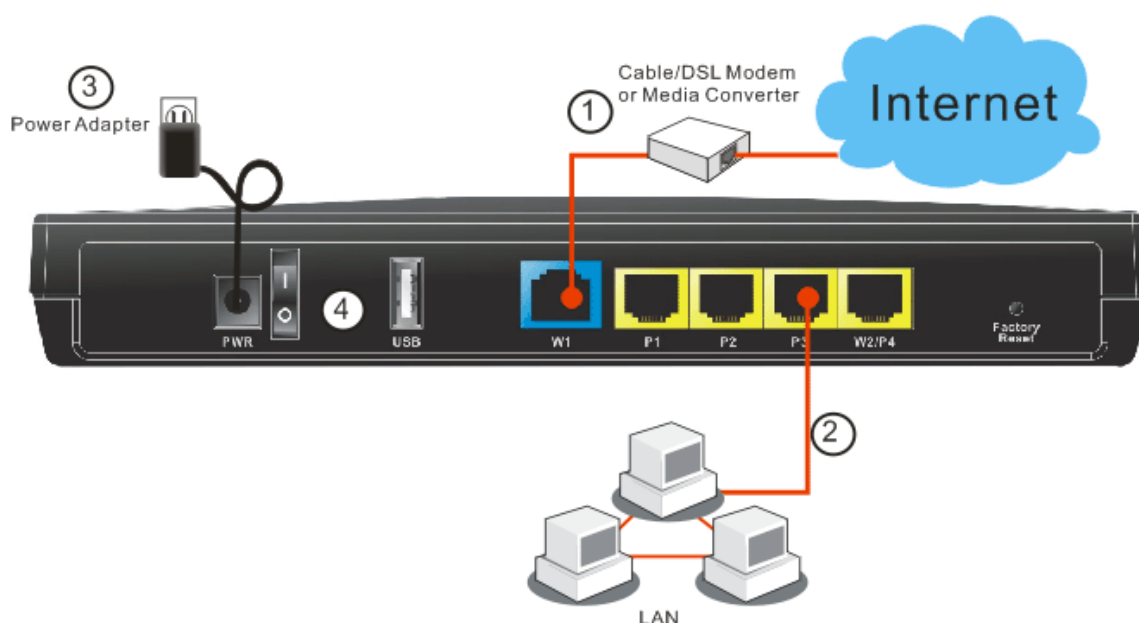

### 3.2 Wall-Mounted Installation

Vigor router has keyhole type mounting slots on the underside.

1. A template is provided on the Vigor router packaging box to enable you to space the screws correctly on the wall.
2. Place the template on the wall and drill the holes according to the recommended instruction.
3. Fit screws into the wall using the appropriate type of wall plug.

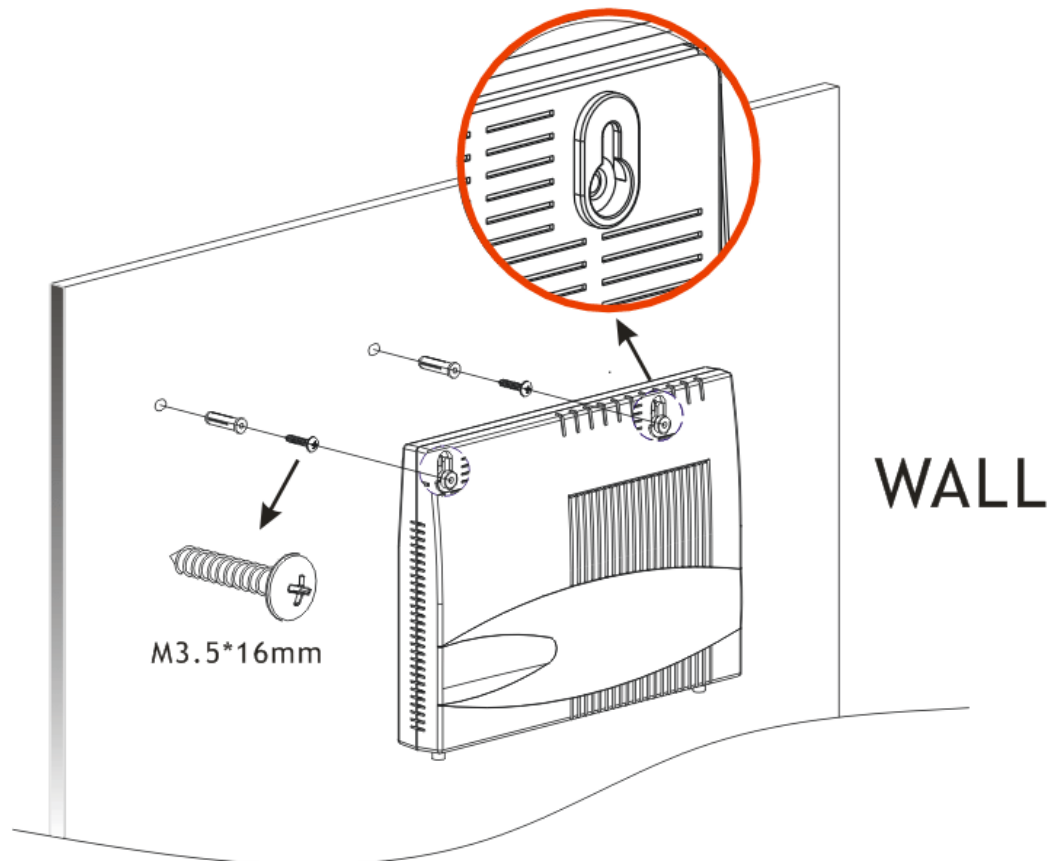

**Note**

The recommended drill diameter shall be 6.5mm (1/4").

4. When you finished about procedure, the router has been mounted on the wall firmly.

## 4. Software Configuration

To access Internet, please finish basic configuration after completing the hardware installation.

The **Quick Start Wizard** is designed for you to easily set up your router for Internet access. You can directly access the **Quick Start Wizard** via Web Configurator.

1. Make sure your PC connects to the router correctly.



---

**Note**

You may either simply set up your computer to get IP dynamically from the router or set up the IP address of the computer to be the same subnet as the **default IP address of Vigor router 192.168.1.1**. For the detailed information, please refer to the later section - Trouble Shooting of the guide.

---

2. Open a web browser on your PC and type **http://192.168.1.1**. A pop-up window will open to ask for username and password. Please type "admin/admin" as the Username/Password and click **Login**.

**DrayTek** **Vigor2915 Series**

**Login**

**Username**

**Password**

**Language**  ▼

**Login**

**Security Warning: You are logging in without encryption which is not recommended. To login securely [click here](#).**

Copyright © 2000-2021 DrayTek Corp. All Rights Reserved.



---

**Note**

If you fail to access to the web configuration, please go to "Trouble Shooting" for detecting and solving your problem.

---

3. Now, the Main Screen will pop up. Click Wizards>>Quick Start Wizard.

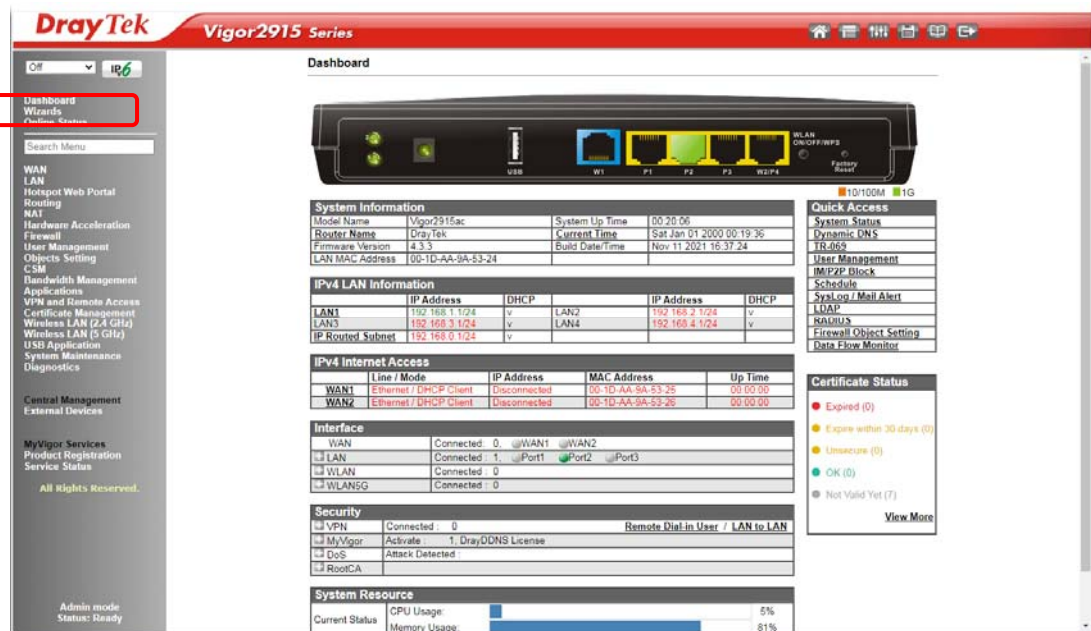

**Note** The home page will change slightly in accordance with the router you have.

4. Enter the login password on the field of New Password and retype it on the field of Confirm Password. Then click Next to continue.

#### Quick Start Wizard

##### Enter login password

Please enter an alpha-numeric string as your **Password** (Max 83 characters)

Old Password

New Password

Confirm Password

Password Strength: Weak Medium Strong

Strong password requirements:

1. Have at least one upper-case letter and one lower-case letter.
2. Including non-alphanumeric characters is a plus.

Hint: If you want to keep the password unchanged, leave the password blank and press "Next" button to skip this process.

< Back Next > Finish Cancel

5. On the next page as shown below, please select the WAN interface that you use. Then click **Next** for next step.

Quick Start Wizard

---

WAN Interface

WAN Interface:	WAN1 ▾
Display Name:	<input type="text"/>
Physical Mode:	Ethernet
Physical Type:	Auto negotiation ▾

< Back   Next >   Finish   Cancel

WAN1 (Ethernet) and WAN2 (Ethernet) will bring up different configuration page. Here we take WAN1 (Ethernet) as an example.

After choosing WAN1, please specify physical type. Then, click **Next**. On the next page as shown below, please select the appropriate Internet access type according to the information from your ISP. For example, you should select PPPoE mode if the ISP provides you PPPoE interface.

## PPPoE

1. Choose **WAN1** as the WAN Interface and click the **Next** button. The following page will be open for you to specify Internet Access Type.

Quick Start Wizard

---

Connect to Internet

**WAN 1**  
Select one of the following Internet Access types provided by your ISP.

- PPPoE
- PPTP
- L2TP
- Static IP
- DHCP

< Back   Next >   Finish   Cancel

2. Click **PPPoE** as the Internet Access Type. Then click **Next** to continue.

Quick Start Wizard

---

PPPoE Client Mode

<b>WAN 1</b>	
Enter the user name and password provided by your ISP.	
Service Name (optional)	<input type="text" value="CHT"/>
Username	<input type="text" value="admin"/>
Password	<input type="password" value="*****"/>
Confirm Password	<input type="password" value="*****"/>

3. Please manually enter the Username/Password provided by your ISP. Click **Next** for viewing summary of such connection.

Quick Start Wizard

---

Please confirm your settings:

WAN Interface:	WAN1
Physical Mode:	Ethernet
Internet Access:	PPPoE

Click **Back** to modify changes if necessary. Otherwise, click **Finish** to save the current settings and restart the Vigor router.

4. Click **Finish**. A page of **Quick Start Wizard Setup OK!!!** will appear. Then, the system status of this protocol will be shown.

**Quick Start Wizard Setup OK!**

5. Now, you can enjoy surfing on the Internet.

## DHCP

1. Choose **WAN1** as WAN Interface and click the **Next** button. The following page will be open for you to specify Internet Access Type.

### Quick Start Wizard

---

#### Connect to Internet

**WAN 1**  
Select one of the following Internet Access types provided by your ISP.

- PPPoE
- PPTP
- L2TP
- Static IP
- DHCP

< Back   Next >   Finish   Cancel

2. Click **DHCP** as the Internet Access type. Simply click **Next** to continue.

### Quick Start Wizard

---

#### DHCP Client Mode

**WAN 1**  
If your ISP requires you to enter a specific host name or specific MAC address, please enter it in.

Host Name     (optional)

MAC                (optional)

< Back   Next >   Finish   Cancel



3. After finished the settings above, click **Next** for viewing summary of such connection.

#### Quick Start Wizard

---

Please confirm your settings:

WAN Interface:	WAN1
Physical Mode:	Ethernet
Internet Access:	DHCP

Click **Back** to modify changes if necessary. Otherwise, click **Finish** to save the current settings and restart the Vigor router.

4. Click **Finish**. A page of **Quick Start Wizard Setup OK!!!** will appear. Then, the system status of this protocol will be shown.

#### Quick Start Wizard Setup OK!

5. Now, you can enjoy surfing on the Internet.

## 5. Customer Service

If the router cannot work correctly after trying many efforts, please contact your dealer/DrayTek for further help right away. For any questions, please feel free to send e-mail to [support@draytek.com](mailto:support@draytek.com).

### **Be a Registered Owner**

Web registration is preferred. You can register your Vigor router via <https://myvigor.draytek.com>.

### **Firmware & Tools Updates**

Due to the continuous evolution of DrayTek technology, all routers will be regularly upgraded. Please consult the DrayTek web site for more information on newest firmware, tools and documents.

<https://www.draytek.com>